



SPECIFICATION:

LENGTH: 59¹/₂"

WIDTH: 30¹/₂"

HEIGHT: 5"

STYLE: Center drain shower base

SHIPPING WEIGHT: 50 LBS*

COLOURS: White

MATERIALS: Gelcoat finish reinforced with fibreglass

MARTINIQUE SERIES

The shower unit is a gel-coated, heavy-duty fiberglass reinforced unit to provide a sanitary, unbroken, smooth surface. Reinforcing and contouring gives added strength. The units have one inch nailing flanges on front and top edges and warranted against factory defects for three years.

Venco Products Ltd. (Delta)

7584 Vantage Place, Delta, BC V4G 1A5

Tel: (604) 940-4960

sales@venco.ca

Venco Products Ltd. (Nanaimo)

1960 Cedar Road, Nanaimo, BC V9X 1L7

Tel: (250) 722-2522

islandsales@venco.ca



VENCO.CA

* APPROXIMATE

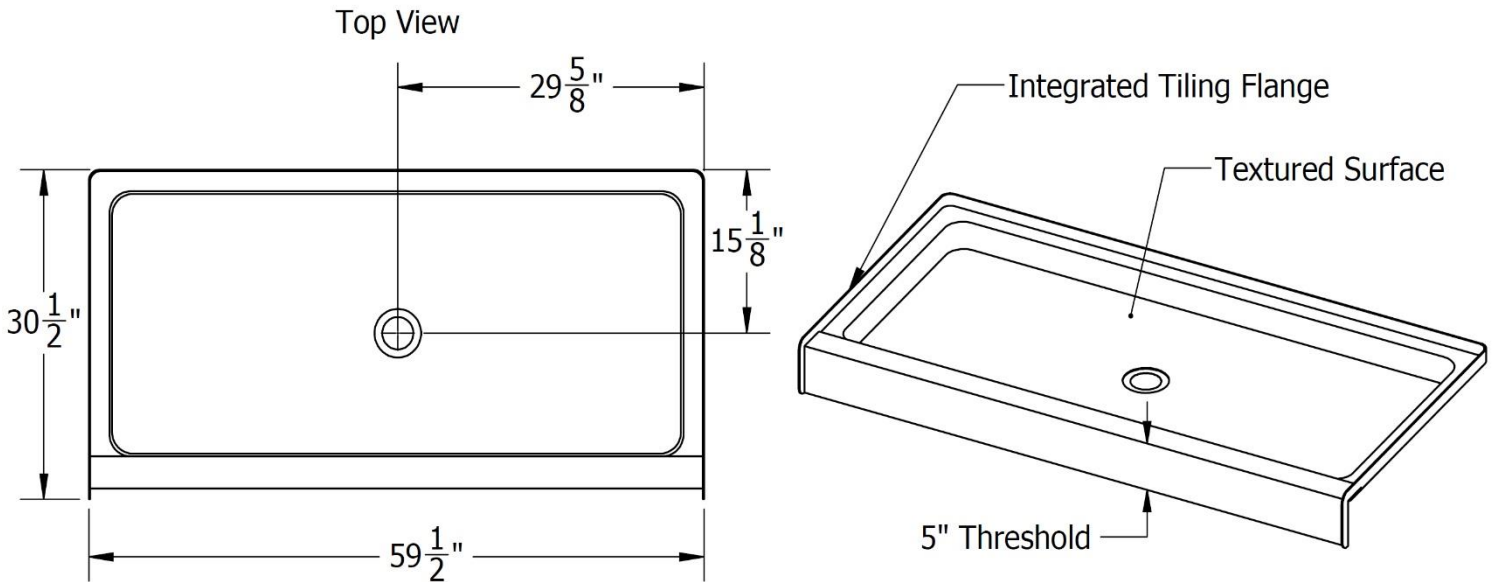

Note: ALL THE MEASUREMENTS ARE IN INCHES & HAVE TOLERANCE OF ± 1/4"

IMPORTANT

While we strive to provide accurate measurements for our customers, sometimes mistakes happen. Our goal is to help things run smoothly from shipment to installation, so if you notice any errors in our spec sheets, please let us know.

Our products are handmade & hand finished so you can expect a tolerance of ± 1/4" on all measurements. We strongly recommend waiting until your ordered product is on-site before attempting any rough-in carpentry or plumbing.

If you want to verify any of our measurements, please feel free to call or email us.

Keeping with our policy of continuing product improvement, Venco Products Ltd. reserves the right to change product specifications without notice.

Venco Products Ltd. (Delta)

7584 Vantage Place, Delta, BC V4G 1A5
Tel: (604) 940-4960
sales@venco.ca

Venco Products Ltd. (Nanaimo)

1960 Cedar Road, Nanaimo, BC V9X 1L7
Tel: (250) 722-2522
islandsales@venco.ca

