



SPECIFICATIONS

LENGTH: 47⁷/₈"

WIDTH: 33⁷/₈"

HEIGHT: 3"

SHIPPING WEIGHT: 45 LBS*

* Approximately

Design Features

- Textured bottom
- Low threshold (3")
- Center drain

NEPAL SERIES

Product Specifications

- 100% acrylic with fiberglass & wood reinforcement
- Leveling feet included
- Integral tiling flange
- Drain hole size: 3"
- 5 Year limited manufacturer's warranty included

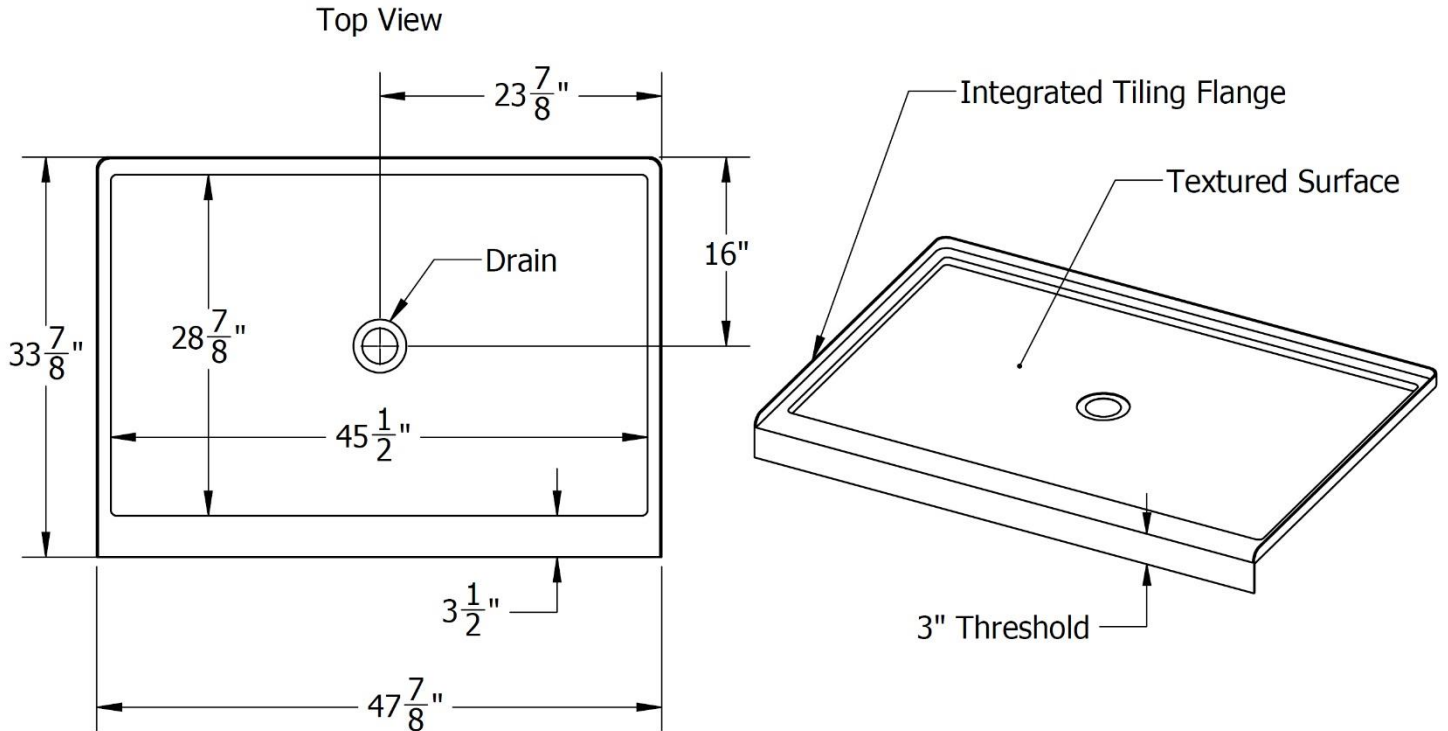

Note: ALL THE MEASUREMENTS ARE IN INCHES & HAVE TOLERANCE OF $\pm 1/4$ "

IMPORTANT

While we strive to provide accurate measurements for our customers, sometimes mistakes happen.

Our goal is to help things run smoothly from shipment to installation, so if you notice any errors in our spec sheets, please let us know.

Our products are handmade & hand finished so you can expect a tolerance of $\pm 1/4$ " on all measurements. We strongly recommend waiting until your ordered product is on-site before attempting any rough-in carpentry or plumbing.

If you want to verify any of our measurements, please feel free to call or email us.

Keeping with our policy of continuing product improvement, Venco Products Ltd. reserves the right to change product specifications without notice.



VENCO.CA

Venco Products Ltd. (Delta)

7584 Vantage Place, Delta, BC V4G 1A5
Tel: (604) 940-4960
sales@venco.ca

Venco Products Ltd. (Nanaimo)

1960 Cedar Road, Nanaimo, BC V9X 1W1
Tel: (250) 722-2522
islandsales@venco.ca